



**Strumento Multifunzione
per reti bassa tensione
4 moduli**

**Network monitor
for low voltage
4 module**

KIT di misura Rogowski
Strumento multifunzione + 3 sensori di
corrente Rogowski
Linea trifase 80...500V (fase-fase)
Inserzione su sensori di corrente
Rogowski dedicati
Rapporto TV esterni programmabile
Sensore di corrente esterno programmabile
Energia cl.1
(multifunzione + sensori corrente)
Uscita impulsi
Comunicazione RS485 protocollo
ModBus RTU/TCP o BACNET
Diagnostica, correzioni sequenza fasi

Rogowski measurement KIT
Network monitor + 3 Rogowski
current sensors
Three-phase network 80...500V (phase-phase)
Connection on dedicated Rogowski
current sensors
Programmable external VT ratio
Programmable external current sensors
Energy cl.1
(multifunction + current sensor)
Pulse output
RS485 communication by
ModBus RTU/TCP or BACNET protocol
Phase sequence correction, diagnostic

Interfacce esterne:
Comunicazione Ethernet (NT809 - NT891)

External interfaces:
Ethernet communication (NT809 - NT891)

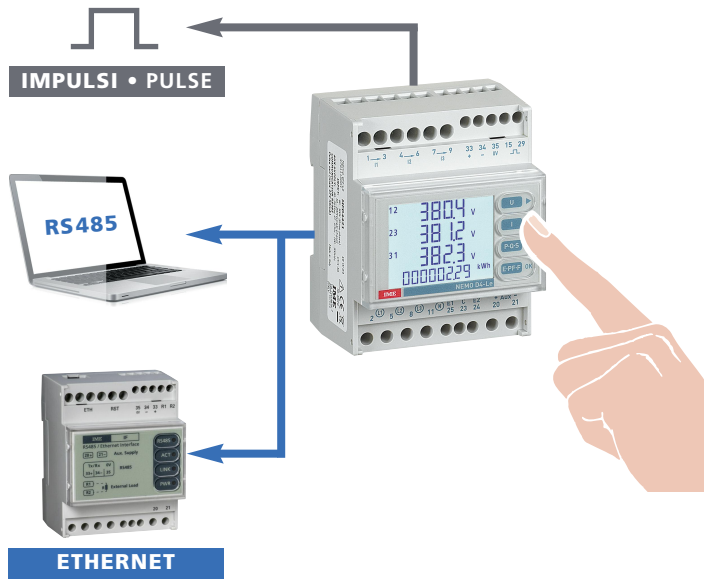

Nemo D4-Le
Rogowski

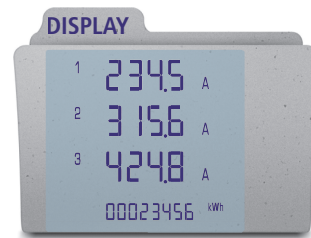

- ▶ **Tensione di fase e concatenata**
Phase and linked voltage
- ▶ **Tensione min. e max. di fase**
Min. and max. phase voltage
- ▶ **Corrente di fase e di neutro**
Neutral and phase current
- ▶ **Corrente media e valore max. corrente media**
Current demand and current max. demand
- ▶ **Frequenza**
Frequency
- ▶ **Fattore di potenza**
Power factor
- ▶ **Potenza attiva, reattiva apparente**
Active, reactive phase power

- ▶ **Potenza media e valore max. potenza media**
Power demand and power max. demand

- ▶ **Energia attiva e reattiva positiva e negativa, totale e parziale**
Total and partial, positive and negative active and reactive energy

- ▶ **Energia attiva tariffaria, 4 tariffe**
Tariff active energy, 4 tariff

- ▶ **Ore e minuti di funzionamento**
Working hours and minutes

- ▶ **THDV e THDI**
THDV and THDI

- ▶ **Analisi armonica**
Harmonic analysis

- ▶ **Fattore di cresta tensione e corrente**
Voltage and current crest factor

- ▶ **Angolo di fase tra corrente e tensione**
Angolo di fase tra le correnti
Angolo di fase tra le tensioni
Phase angle between current and voltage
Phase angle between currents
Phase angle between voltages

- ▶ **Conteggio impulsi, 2 ingressi**
Pulse count, 2 input

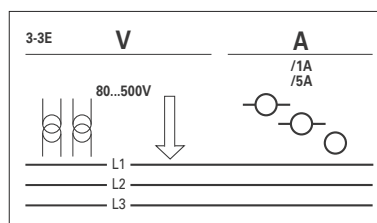
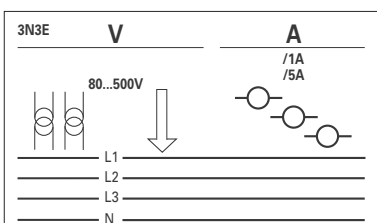
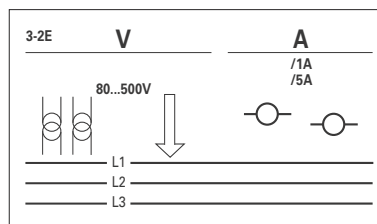
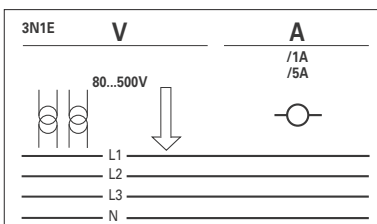
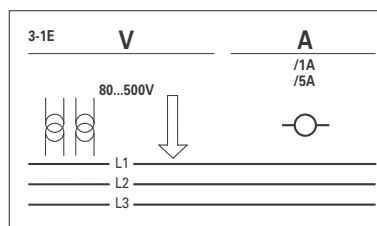
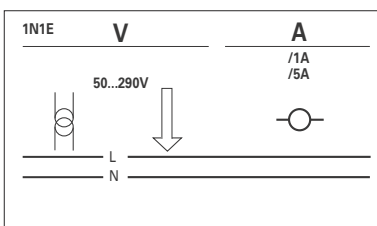

		MODELLO MODEL	Nemo D4 Le	
		LINEA NETWORK	bt / LV	
INGRESSO INPUT	CONNESSIONE CONNECTION	Monofase / Single-phase	✓	
		Trifase, carico equilibrato Three-phase, balanced load	✓	
		Trifase, carico squilibrato Three-phase, unbalanced load	✓	
	DIAGNOSTICA, CORREZIONI SEQUENZA FASI / PHASE SEQUENCE CORRECTION, DIAGNOSTIC			✓
	VALORI NOMINALI RATED VALUE	Tensione / Voltage		100 - 400V
		Corrente / Current		seniore Rogowski
	INGRESSO CORRENTE INPUT CURRENT	TA dedicati / Dedicated CT		✓
		Isolato / Insulated		
	RAPPORTO PROGRAMMABILE PROGRAMMABLE RATIO	TV (kTV) / VT (kVT)		1...10
		TA/CT	Portate / Ranges	
I _{pn}				1000-3000-5000A
max. kTV x kTA / max. kVT x kCT			99'990	
Shunt				
ENERGIA ATTIVA ACTIVE ENERGY	Precisione / Accuracy EN/IEC61557-12		cl.1	
	Precisione energia cc Energy accuracy dc			
	Positiva, totale e parziale Positive, total and partial		✓	
ENERGIA REATTIVA REACTIVE ENERGY	Negative, totale / Negative total		✓	
	Precisione / Accuracy EN/IEC61557-12		cl.1	
	Positiva, totale / Positive, total		✓	
	Positiva, parziale / Positive, partial		✓	
TENSIONE VOLTAGE	Negativa, totale / Negative, total		✓	
	di Fase e concatenata / Phase and linked		✓	
CORRENTE CURRENT	di Fase e di neutro (calcolata) Phase and neutral (computed)		✓	
	di Neutro (misurata) Neutral (measured)			
FATTORE DI POTENZA POWER FACTOR	Media e media massima di fase Phase demand and max. demand		✓	
	Trifase / Three-phase		✓	
POTENZA POWER	Di fase / Phase		✓	
	Attiva, reattiva, apparente Active, reactive, apparent		✓	
	Media e media massima Demand and max. demand		✓	
	Attiva e reattiva di fase Phase active and reactive		✓	
DISTORSIONE ARMONICA Corrente / Tensione HARMONIC DISTORTION Current / Voltage	THD		✓	
	Analisi / Analysis		✓	
FREQUENZA / FREQUENCY			✓	
MISURA C.C. ¹ / D.C. ¹ MEASURE				
CONTAORE / RUN HOUR METER			✓	
SEQUENZA FASI ERRATA / WRONG PHASE SEQUENCE			✓	
TEMPERATURA / TEMPERATURE				
USCITE OUTPUT	IMPULSI / PULSES		◆	
	RELE' ALLARMI / ALARM RELAYS		◆	
	RELE' ALLARMI + INGRESSI DIGITALI / ALARM RELAYS + DIGITAL INPUTS			
	ANALOGICA / ANALOGUE			
COMUNICAZIONE COMMUNICATION	RS232			
	RS485 MODBUS RTU		●	
	RS485 + MEMORIA / RS485 + MEMORY			
	PROFIBUS			
	LONWORKS			
	M-BUS			
	BACNET		●	
	ETHERNET		RS485 + IF2E011	
TRASMISSIONE RADIO 868MHz / 868MHz RADIO TRANSMISSION				

¹ Tensione, corrente, potenza, Ah positivi e negativi / ¹ Voltage, current, power, Ah positive and negative

◆ in alternativa On choice ● in alternativa On choice

CODICI DI ORDINAZIONE ORDERING CODE	INGRESSO INPUT			USCITA OUTPUT	AL.AUSILIARIA AUX.SUPPLY
	Sensore Rogowski Rogowski sensor	A	V		
KRNEMOD4LE080	∅ 80mm	20...5000A	80...500V	Impulsi energia / Pulse energy RS485 ModBus RTU/TCP	80...265Vca/ac 100...300Vcc/dc
KRNEMOD4LE142	∅ 142mm				
KRNEMOD4LE190	∅ 190mm				
KRNEMOD4LEB080	∅ 80mm			Impulsi energia / Pulse energy RS485 BACNET	
KRNEMOD4LEB142	∅ 142mm				
KRNEMOD4LEB190	∅ 190mm				

COMPOSIZIONE KIT KIT COMPOSITION		N°3 sensori Rogowski N°3 Rogowski sensor		N° 1 Nemo D4-Le Rogowski			
CODICE CODE	DIAMETRO DIAMETER	A	CODICE CODE	INGRESSO INPUT	USCITA OUTPUT	AL.AUSILIARIA AUX.SUPPLY	CODICE CODE
KRNEMOD4LE080	∅ 80mm	20...5000A	SR01D080	80...500V Sensore Rogowski Sensor	impulsi energia Pulse energy RS485 ModBus RTU/TCP	80...265Vca/ac 100...300Vcc/dc	MFD4421SR
KRNEMOD4LE142	∅ 142mm		SR01D142				
KRNEMOD4LE190	∅ 190mm		SR01D190				
KRNEMOD4LEB080	∅ 80mm		SR01D080		impulsi energia Pulse energy RS485 BACNET		MFD44B1SR
KRNEMOD4LEB142	∅ 142mm		SR01D142				
KRNEMOD4LEB190	∅ 190mm		SR01D190				

LEGENDA:

 = Parametro Programmabile
 = Parametro Azzerabile

LEGEND:

 = Programmable Parameter
 = Reset Parameter

VISUALIZZAZIONE

Tipo display: cristallo liquido retroilluminato

 **Retroilluminazione selezionabile:** 0 – 35 – 70 – 100%

Riduzione automatica della retroilluminazione (al valore selezionato) dopo 20 secondi circa di inattività della tastiera

Retroilluminazione 100% alla prima pressione sulla tastiera

Punti di lettura: 10'000 4 cifre (altezza cifre 12mm)

Unità ingegneristica: visualizzazione automatica in funzione dei rapporti TA e TV impostati

Risoluzione: automatica

Punto decimale: automatico

Aggiornamento display: 1 lettura/s

Conteggio energia: 8 cifre

La visualizzazione è suddivisa in 4 menù, accessibili con i relativi tasti funzione:



Le pagine di visualizzazione variano in funzione della misura programmata

PARAMETRI PROGRAMMABILI

Programmazione: tramite tastiera frontale touc-screen, 4 tasti

Accesso programmazione: protetto da password

Menù programmazione: suddiviso su due livelli

LIVELLO 1

- Pagina visualizzazione personalizzata
- Connessione
- Tempo integrazione corrente/potenza media
- Retroilluminazione display
- Avvio conteggio contaore
- Comunicazione RS485
- Funzione uscita relè impulsi o allarme o commutazione stato

LIVELLO 2

- Modalità conteggio energia
- Rapporto trasformazione TV esterni e corrente nominale

DISPLAY

Type of display: backlitged liquid crystal

 **Selectable backlighting:** 0 – 35 – 70 – 100%

Backlighting automatic reduction (to the selected value) after approximately 20 seconds of keyboard idle

100% backlighting after first pressure on the keyboard

Reading points: 10.000 4 digits (digit height 12mm)

Engineering unit: automatic display according to the loaded VT and CT ratios

Resolution: automatic

Decimal point: automatic

Display updating: 1 reading/s

Energy count: 8 digits

Display is subdivided into 4 menus which are accessible through the relevant function keys:

Display pages change according to the programmed measuring mode

PROGRAMMABLE PARAMETERS

Programming: through touch-screen front keyboard, 4 keys

Programming access: password-protected

Programming menu: subdivided on two levels

LEVEL 1

- Customized display page
- Connection
- Average power/current delay time
- Display backlighting
- Lapsed time count start
- RS485 communication
- Relay output function pulses or alarm or state switching

LEVEL 2

- Energy count mode
- External VT ratio and current rating

MODALITÀ CONTEGGIO ENERGIA

4 modalità selezionabili: sincrona, asincrona, tariffaria, contaimpulsi

	Conteggio Energia Parziale Partial Energy Count	Energia 4 Tariffe Energy 4 Tariffs	Conteggio Impulsi Pulse Counter
SINCRONA Synchronous	Attivato da ingressi digitali Activated by digital inputs	–	–
ASINCRONA Asynchronous	Sempre attivo Always active	–	–
TARIFFARIA Tariff	–	Commutazione tariffa con ingressi digitali Tariff switching with digital inputs	–
CONTAIMPULSI Pulse counting	Sempre attivo Always active	–	Attivato da ingressi digitali Activated by digital inputs

ENERGY COUNT MODE

4 selectable modes: synchronous, asynchronous, tariff, pulse counting

PAGINE VISUALIZZAZIONE CONNESSIONE 3N3E

SINCRONA - ASINCRONA - CONTAIMPULSI

3N3E CONNECTION PAGES DISPLAYING

SYNCHRONOUS - ASYNCHRONOUS - PULSE COUNTING



TENSIONE di fase e concatenata VOLTAGE phase and linked	CORRENTE di fase e di neutro CURRENT phase and neutral	POTENZA TRIFASE attiva, reattiva, apparente, distorcente ¹ THREE-PHASE POWER active, reactive, apparent, distorting ¹	FATTORE DI POTENZA di fase e trifase POWER FACTOR phase and three-phase
✗ TENSIONE MINIMA di fase MINIMUM VOLTAGE phase	CORRENTE MEDIA di fase CURRENT DEMAND phase	POTENZA FASE attiva, reattiva, apparente PHASE POWER active, reactive, apparent	ANGOLO DI FASE TENSIONE-CORRENTE di fase e trifase PHASE ANGLE CURRENT-VOLTAGE phase and three-phase
✗ TENSIONE MASSIMA di fase MAXIMUM VOLTAGE phase	✗ PICCO CORRENTE MEDIA di fase MAX. CURRENT DEMAND phase	POTENZA MEDIA attiva, reattiva, apparente POWER DEMAND active, reactive, apparent	FREQUENZA FREQUENCY
DISTORSIONE ARMONICA TENSIONE di fase o concatenata VOLTAGE HARMONIC DISTORTION phase or linked	MEDIA DELLE 3 CORRENTI AVERAGE CURRENT $\frac{I_1 + I_2 + I_3}{3}$	✗ PICCO POTENZA MEDIA attiva, reattiva, apparente MAX. POWER DEMAND active, reactive, apparent	✗ CONTAORE RUN HOUR METER
ANALISI ARMONICA ² di fase o concatenata H03/05/07/09 HARMONIC ANALYSIS ² phase or linked	DISTORSIONE ARMONICA CORRENTE di fase CURRENT HARMONIC DISTORTION phase		ENERGIA ATTIVA TOTALE Positiva e Negativa TOTAL ACTIVE ENERGY Positive and Negative
FATTORE DI CRESTA CREST FACTOR	ANALISI ARMONICA ² di fase H03/05/07/09 HARMONIC ANALYSIS ² phase		ENERGIA REATTIVA TOTALE Positiva e Negativa TOTAL REACTIVE ENERGY Positive and Negative
ANGOLO DI FASE fra le tensioni PHASE ANGLE between voltages	FATTORE DI CRESTA CREST FACTOR		✗ ENERGIA ATTIVA PARZIALE Positiva e Negativa PARTIAL ACTIVE ENERGY Positive and Negative
	ANGOLO DI FASE fra le correnti PHASE ANGLE between currents		✗ ENERGIA REATTIVA PARZIALE Positiva e Negativa PARTIAL REACTIVE ENERGY Positive and Negative
			✗ CONTEGGIO IMPULSI Stato Ingresso Impulsi PULSE METERING State of Pulse Input

TARIFFARIA

TARIFF

TENSIONE di fase e concatenata VOLTAGE phase and linked	CORRENTE di fase e di neutro CURRENT phase and neutral	POTENZA TRIFASE attiva, reattiva, apparente, distorcente' THREE-PHASE POWER active, reactive, apparent, distorting'	FATTORE DI POTENZA di fase e trifase POWER FACTOR phase and three-phase
✗ TENSIONE MINIMA di fase MINIMUM VOLTAGE phase	CORRENTE MEDIA di fase CURRENT DEMAND phase	POTENZA FASE attiva, reattiva, apparente PHASE POWER active, reactive, apparent	ANGOLO DI FASE TENSIONE-CORRENTE di fase e trifase PHASE ANGLE CURRENT-VOLTAGE phase and three-phase
✗ TENSIONE MASSIMA di fase MAXIMUM VOLTAGE phase	✗ PICCO CORRENTE MEDIA di fase MAX. CURRENT DEMAND phase	POTENZA MEDIA attiva, reattiva, apparente POWER DEMAND active, reactive, apparent	FREQUENZA FREQUENCY
DISTORSIONE ARMONICA TENSIONE di fase o concatenata VOLTAGE HARMONIC DISTORTION phase or linked	MEDIA DELLE 3 CORRENTI AVERAGE CURRENT $\frac{I_1 + I_2 + I_3}{3}$	✗ PICCO POTENZA MEDIA attiva, reattiva, apparente tariffa 1/2/3/4 MAX. POWER DEMAND active, reactive, apparent tariff1/2/3/4	✗ CONTAORE RUN HOUR METER
ANALISI ARMONICA² di fase o concatenata H03/05/07/09 HARMONIC ANALYSIS² phase or linked	DISTORSIONE ARMONICA CORRENTE di fase CURRENT HARMONIC DISTORTION phase		ENERGIA ATTIVA POSITIVA POSITIVE ACTIVE ENERGY
FATTORE DI CRESTA CREST FACTOR	ANALISI ARMONICA² di fase H03/05/07/09 HARMONIC ANALYSIS² phase		ENERGIA REATTIVA POSITIVA POSITIVE REACTIVE ENERGY
ANGOLO DI FASE fra le tensioni PHASE ANGLE between voltages	FATTORE DI CRESTA CREST FACTOR		ENERGIA ATTIVA NEGATIVA NEGATIVE ACTIVE ENERGY
	ANGOLO DI FASE fra le correnti PHASE ANGLE between currents		ENERGIA REATTIVA NEGATIVA NEGATIVE REACTIVE ENERGY
			ENERGIA ATTIVA tariffa 1/2/3/4 ACTIVE ENERGY tariff1/2/3/4

POTENZA DISTORCENTE

¹Nei sistemi trifase, normalmente la relazione fra P,Q ed S è la seguente:

$$S = V \times I = \sqrt{P^2 + Q^2}$$

Questo vale in assenza di distorsione armonica.

Ove sia presente distorsione di corrente, la relazione deve essere corretta nel modo seguente:

$$S = V \times I = \sqrt{P^2 + Q^2 + D^2}$$

dove D assume il significato di potenza "distorcente".

ANALISI ARMONICA

²Il calcolo del contenuto spettrale del segnale tiene conto anche della possibile distribuzione di inter-armoniche che tipicamente si ritrova nelle forme d'onda ciclicamente interrotte.

In questi casi non vi sono armoniche alle frequenze multiple della fondamentale ma all'interno degli intervalli fra una armonica e la successiva:

es.: 50Hz (fondamentale)

inter-armoniche: 87,5Hz (50-100Hz) o 112,5Hz (100-150Hz)

Al fine di poter presentare i dati in modo standard, il contenuto spettrale nell'esempio viene attribuito, alla frequenza intermedia più vicina ovvero 100Hz (seconda armonica).

DISTORTING POWER

¹In normal 3-phase systems, usually the relationship between P,Q and S is as in the following:

$$S = V \times I = \sqrt{P^2 + Q^2}$$

This is true whwn no distortionis present in the currents. When the currents have some way a harmonic contents, yhe formula must be corrected in this way:

$$S = V \times I = \sqrt{P^2 + Q^2 + D^2}$$

where D has the meaning "deforming" power.

HARMONIC ANALYSE

²The calculation of the harmonic contents of the incoming signal keeps in account the possible presence of inter-harmonics that normally is found when the waveform is cyclically interrupted (burst fired).

In these cases, there aren't any harmonics at frequencies multiple of the fundamental but in the ranges between two consecutive values:

eg.: 50Hz (fundamental)

inter-harmonics: 87,5Hz (50-100Hz) or 112,5Hz (100-150Hz)

To show the results in a standard way, the harmonic contents, as in the example, are correctly attributed to the nearest central harmonic in the range 50...150Hz that is 100Hz (second harmonic).

PRECISIONE IN CONFORMITA' ¹	CONFORMITY ACCURACY WITH	EN/IEC 61557-12	
Energia attiva	Active energy	Ea	cl.1
Energia reattiva	Reactive energy	Erv	cl.1
Tensione	Voltage	U	cl.0,5
Corrente	Current	I	cl.1
Potenza attiva	Active power	P	cl.1
Potenza reattiva	Reactive power	Qv	cl.1
Potenza apparente	Apparent power	Sv	cl.1
Frequenza	Frequence	f	± 0,1Hz
THD (fino a 50 ^a armonica) Singole armoniche	THD (up to 50 th harmonic) Harmonics single	THDu / THDi	cl.1

Aggiornamento misura: 5 letture/s

Measuring updateing: 5 reading/sec

INGRESSO

 **Connessione:** rete monofase - trifase 3 e 4 fili

Tensione trifase nominale Un: 400-100V (fase-fase)

Tensione trifase: 80...500V (fase-fase)

Tensione monofase nominale Un: 230V

Tensione monofase: 50...290V

 **Rapporto TV esterno:** 1...10,0 (max. tensione primaria TV 1200V)

Inserzione su sensori Rogowski dedicati

 **Campo di misura:** 20...1000A - 60...3000A - 100...5000A

L'uscita del sensore è un segnale in mV, senza pericolo per secondari aperti

Frequenza nominale fn: 50Hz - 400Hz (selezione automatica)

Variazione ammessa: 45...65Hz (fn 50Hz) - 360...440Hz (fn 400Hz)

Tipo di misura: vero valore efficace

Contenuto armonico: fino a 40^a armonica (45...65Hz)

Fattore di cresta corrente: 2

Tempo di avviamento (conteggio energia): < 5s

Autoconsumo tensione: ≤ 0,2VA (fase-neutro alla tensione nominale)

Autoconsumo corrente: nullo

L'assenza di nucleo magnetico, consente di non assorbire potenza dal circuito di misura

INGRESSI DIGITALI

2 ingressi digitali attivi, con differente utilizzo in modalità conteggio selezionata

Sincrona: attivazione conteggio energia parziale attiva e/o reattiva

Asincrona: ingressi digitali non utilizzati

Tariffaria: Commutazione tariffa 1 / 2 / 3 / 4

Contaimpuls: conteggio impulsi ingresso 1 e 2

3 terminali di ingresso con punto comune (morsetti 23-24-25)

Massima tensione ingresso: 27V

Massima frequenza impulsi ingresso: 15Hz

POTENZA MEDIA

Grandezza: potenza attiva

Calcolo: media fissa, sul periodo selezionato

 **Tempo integrazione:** 5/8/10/15/20/30/60 min.

Tempo integrazione: unico per tutte le grandezze

CONTAORE

Conteggio ore e minuti

 **Avvio conteggio:** selezionabile, presenza tensione opp. potenza

Tensione: tensione di fase > 20V

 **Potenza:** potenza nominale attiva trifase

 **Valore programmabile:** 0,5...50%Pn

Pn = Potenza nominale attiva trifase = Tensione trifase nominale Un x Corrente In x $\sqrt{3}$

Un = 400V

In = 1A opp. 5A

Pn = 400V x 5A x $\sqrt{3}$ = 3464W opp. 400V x 1A x $\sqrt{3}$ = 692,8W

USCITA RELÈ

Funzione uscita: impulsi energia, contatto allarme, commutazione stato relè (comandato da remoto) modalità bistabile, commutazione stato relè (comandato da remoto) modalità temporizzata.

USCITA IMPULSI ENERGIA

Uscita impulsi compatibile con S0 EN/IEC 62053-31

Optorelè con contatto SPST-NO libero da potenziale

Portata contatti: 27Vdc/ca - 50mA

 **Energia associata:** attiva o reattiva

 **Peso impulso:** 1imp/10Wh(varh) - 100Wh(varh) - 1kWh(kvarh) - 10kWh(kvarh) - 100kWh(kvarh) - 1MWh(Mvarh) - 10MWh(Mvarh)

 **Durata impulso:** 50 - 100 - 200 - 300 - 400 - 500ms

INPUT

 **Connection:** single-phase and three-phase network, 3 and 4-wire

Three-phase voltage rating Un: 400-100V (phase-phase)

Three-phase voltage: 80...500V (phase-phase)

Single-phase voltage rating Un: 230V

Single-phase voltage: 50...290V

 **External VT ratio:** 1...10,0 (max. VT primary 1200V)

Connection with Rogowski current sensor dedicated

 **Measuring range:** 20...1000A - 60...3000A - 100...5000A

Sensor output is a mV, signal without any danger for open secondary windings

Frequency rating fn: 50Hz - 400Hz (automatic selection)

Tolerance: 45...65Hz (fn 50Hz) - 360...440Hz (fn 400Hz)

Type of measurement: true RMS value

Harmonic content: up to 40th harmonic (45...65)

Current peak factor: 2

Start time (energy count): < 5s

Voltage rated burden: 0,2VA (neutral-phase to voltage rating)

Current rated burden: void

The absence of a magnetic core allows to avoid absorption of power from the measuring circuit

DIGITAL INPUTS

2 active digital inputs, with different use according to the selected count mode

Synchronous: active and/or reactive partial energy count activation

Asynchronous: unused digital inputs

Tariff: tariff switching 1 / 2 / 3 / 4

Pulse metering: pulse metering for input 1 and 2

3 input terminals with common point (terminals 23-24-25)

Max. input voltage: 27V

Max. input pulse frequency: 15Hz

POWER DEMAND

Quantity: active power

Calculation: average on the selected time interval

 **Delay time:** 5/8/10/15/20/30/60 min.

Average period: only for all quantity

RUN HOUR METER

Hours and minutes count

 **Count start:** power or voltage present selectable

Voltage: phase-voltage > 20V

 **Power:** 3-phase active power rating

 **Programmable value:** 0,5...50%Pn

Pn = 3-phase active power rating = 3-phase active voltage rating Un x Current In x $\sqrt{3}$

Un = 400V

In = 1A or. 5A

Pn = 400V x 5A x $\sqrt{3}$ = 3464W or. 400V x 1A x $\sqrt{3}$ = 692,8W

RELAY OUTPUT

Output function: energy pulses, alarm contact, state of relay switching (remote-controlled), bistable mode, state of relay switching (remote-controlled), timed mode

ENERGY PULSE OUTPUT

Pulse output compatible with S0 EN/IEC 62053-31

Optorelay with potential-free SPST-NO contact

Contact range: 27Vdc/ac - 50mA

 **Associated energy:** active or reactive

 **Weight of pulse:** 1 pulse/10Wh(varh) - 100Wh(varh) - 1kWh(kvarh) - 10kWh(kvarh) - 100kWh(kvarh) - 1MWh(Mvarh) - 10MWh(Mvarh)

 **Pulse duration:** 50 - 100 - 200 - 300 - 400 - 500ms

ALLARME

1 Allarme programmabile

In caso di intervenuto allarme, il display lampeggia, per segnalare l'anomalia. Premendo più volte il tasto **et** è possibile visualizzare la grandezza abbinata all'allarme ed il tipo di allarme (min. o max.)

Optorelè con contatto SPST-NO libero da potenziale

Portata contatti: 27Vcc/ca – 50mA

Grandezza associabile:

tensione di fase L1-N / L2-N / L3-N
tensione concatenata L1-L2 / L2-L3 / L3-L1
corrente di fase I1 / I2 / I3
frequenza
potenza attiva trifase
potenza reattiva trifase

Soglia intervento

 **Tipo allarme:** minima o massima

 **Contatto uscita relè:** norm. aperto o norm. chiuso

 **Isteresi:** 0...20%

 **Ritardo intervento:** 0...99s

 **Ritardo ripristino:** 0...99s

Commutazione stato relè (comandato da remoto) modalità bistabile

 **Contatto uscita relè:** normalmente aperto (no) o normalmente chiuso (nC)

 **t on:** ritardo tra il comando remoto di attivazione e il cambio di stato del relè

 **t oF:** ritardo tra il comando remoto di ripristino e il cambio di stato del relè

 **Valori selezionabili t on / t oF:** 0...99s

Commutazione stato relè (comandato da remoto) modalità temporizzata

 **Contatto uscita relè:** normalmente aperto (no) o normalmente chiuso (nC)

 **t on:** ritardo tra il comando remoto di attivazione e il cambio di stato del relè

 **t oF:** ritardo tra il cambio di stato del relè (attivazione) e il ripristino

 **Valori selezionabili t on / t oF:** 0...99s

DIAGNOSTICA, CORREZIONE SEQUENZA FASI

Nel software del dispositivo è presente un algoritmo di diagnostica e di riparazione della sequenza di inserzione voltmetrica ed amperometrica. La funzione è attivabile a richiesta con password e consente di visualizzare e modificare via software la sequenza di cablaggio a patto che le seguenti condizioni siano rispettate:

- 1) Il conduttore di neutro (nella rete a 4 fili) sia correttamente posizionato al morsetto corrispondente (normalmente numero 11).
- 2) Non siano presenti incroci di conduttori fra TA differenti (es. sulla fase 1 del dispositivo vi sia un cavo proveniente dal TA 1 e sull'altro un cavo dal TA 2).
- 3) Il fattore di potenza sia compreso fra 1 e 0,5 Induttivo per ciascuna fase.

Vedi www.imeitaly.com "SUPPORTO TECNICO".

COMUNICAZIONE RS485 Modbus

Isolata galvanicamente da ingresso e ausiliaria

Standard: RS485 – 3 fili

Trasmisione: asincrona seriale

Protocollo: Modbus RTU – Modbus TCP (autoriconoscimento)

 **N° indirizzo:** 1...255

Numero bit: 8

Bit di stop: 1

Bit di parità: nessuna – pari – dispari

 **Tempo di attesa alla risposta:** 3...100ms

 **Velocità trasmissione:** 4'800 – 9'600 – 19'200 – 38'400 bit/s

 **Formato word messaggio Modbus:** Big Endian, Little Endian, Swap

Esempio Messaggio richiesta: **01 03 10 00 00 02 C0 CB**

Risposta:

Big Endian = **01 03 04 01 02 03 04 CB XX YY**

Little Endian = **01 03 04 04 03 02 01 CB XX YY**

Swap = **01 03 04 03 04 01 02 CB XX YY**

N° massimo di apparecchi collegabili in rete: 32 (fino a 255 con ripetitore RS485)

Distanza massima dal supervisore: 1200m

ALARM

1 Programmable alarm

In case an alarm occurred, the display is blinking to signal the anomaly.

*By pressing many times **et** key it is possible to display the quantity coupled with the alarm as well as the alarm type (min. or max.)*

Optorelay with potential-free SPST-NO contact

Contact range: 27Vdc/ac – 50mA

Quantities that can be associated:

phase voltage L1-N / L2-N / L3-N
interlinked voltage L1-L2 / L2-L3 / L3-L1
phase current I1 / I2 / I3
frequency

3-phase active power

3-phase reactive power

Intervention threshold

 **Type alarm:** min. or max.

 **Relay output contact:** normally open or normally closed

 **Hysteresis:** 0...20%

 **Intervention delay:** 0...99s

 **Reset delay:** 0...99s

State of relay switching (remote-controlled), bistable mode

 **Relay output contact:** normally open (no) or normally closed (nC)

 **t on:** delay between activation remote control and change of state of relay

 **t oF:** delay between reset remote control and change of state of relay

 **Selectable values t on / t oF:** 0...99s

State of relay switching (remote-controlled), timed mode

 **Relay output contact:** normally open (no) or normally closed (nC)

 **t on:** delay between activation remote control and change of state of relay

 **t oF:** delay between change of state of relay (activation) and reset

 **Selectable values t on / t oF:** 0...99s

PHASE SEQUENCE CORRECTION, DIAGNOSTIC

In the software of the device IME have added a specific functionality to detect and correct many problems concerning voltage and / or current connection.

This function can be activated through password and allows to display and modify the connection sequence provided that the following conditions are respected:

- 1) *The neutral wire (in a 4-wire network) is connected to the right terminal (normally number 11).*
- 2) *No crossings between cables connected to CTs (e.g. avoid that on phase 1 of the meter -terminals 1 and 3 - are connected some way both to CT1 and CT2).*
- 3) *The power factor is between 1 and 0,5 - Inductive load - for each phase.*

See www.imeitaly.com "TECHNICAL SUPPORT".

Modbus RS485 COMMUNICATION

Galvanically insulated from input and auxiliary supply

Standard: RS485 – 3 wires

Transmission: serial asynchronous

Protocol: Modbus RTU – Modbus TCP (autorecognition)

 **Number of address:** 1...255

Number of bits: 8

Stop bit: 1

Parity bit: none – even – odd

 **Answer waiting time:** 3...100ms

 **Transmission speed:** 4'800 – 9'600 – 19'200 – 38'400 bit/second

 **Modbus word message format:** Big Endian, Little Endian, Swap

Example Request message: **01 03 10 00 00 02 C0 CB**

Risposta:

Big Endian = **01 03 04 01 02 03 04 CB XX YY**

Little Endian = **01 03 04 04 03 02 01 CB XX YY**

Swap = **01 03 04 03 04 01 02 CB XX YY**

Max. number of devices that can be network-connected: 32 (up to 255 with RS485 repeater)

Max. distance from the supervisor: 1200m

COMUNICAZIONE RS485 BACNET

Isolata galvanicamente da ingresso e ausiliaria

Standard: RS485 – 3 fili

Trasmisione: asincrona seriale

Protocollo: BACNET MS-TP

 N° indirizzo: 0...127

 Velocità trasmissione: 9'600 – 19'200 – 38'400 – 76'800 bit/s

Numero bit: 8

Bit di stop: 1

Bit di parità: nessuna – pari – dispari

 Indirizzo di rete: 0...4000

N° max. di apparecchi collegabili in rete: 32 (fino a 255 con ripetitore RS485)

Distanza massima dal supervisore: 1200m

COMUNICAZIONE ETHERNET (NT809 - NT891)

Realizzabile con interfaccia IF2E011, IF2E111 o IF4E011 (RS485/Ethernet)

ALIMENTAZIONE AUSILIARIA

Valore nominale Uaux ca: 80...265Vca - 48Vca

Frequenza nominale fn: 50 opp. 400Hz (selezione automatica)

Frequenza di funzionamento: 45...65Hz (fn 50Hz) opp. 360...440Hz (fn 400Hz)

Autoconsumo: ≤ 2,5VA (230Vca backlight 30%)

Valore nominale Uaux cc: 100...300Vcc

Autoconsumo: ≤ 2,5W (24Vca backlight 30%)

Protezione contro l'inversione di polarità

COMPATIBILITA' ELETTROMAGNETICA

Emissione in accordo con EN / IEC 61326-1 classe B

Immunità in accordo con EN / IEC 61326-1

ISOLAMENTO

(EN/IEC 61010-1)

Categoria di installazione: III

Grado di inquinamento: 2

Tensione di riferimento per l'isolamento MFD4421SR: 300V (Fase - neutro)

Tensione di riferimento per l'isolamento SR01D...: 1000V

Circuiti considerati	Considered circuits
Alimentazione / Ingressi voltmetrici	Supply / Voltmetric inputs
Ingressi misura / Comunicazione RS485	Measure inputs / RS485 Communication
Ingressi misura / Uscita impulsi	Measure inputs / Pulse output
MF96421SR	
Tutti i circuiti e massa	All circuits and earth
SR01D...	
Tutti i circuiti e massa	All circuits and earth

CONDIZIONI AMBIENTALI

Temperatura di riferimento: 23°C ± 2°C

Campo di funzionamento specificato: -5...55°C

Campo limite per l'immagazzinamento e trasporto: -25...70°C

Adatto all'utilizzo in climi tropicali

Massima potenza dissipata¹: ≤ 5W

¹Per il dimensionamento termico dei quadri

Sensore SR01D...

Temperatura di riferimento: 23°C ± 2°C

Campo di funzionamento specificato: -30...80°C

Campo limite per l'immagazzinamento e trasporto: -40...80°C

CUSTODIA

Multifunzione MFD4421SR

Custodia: 4 moduli DIN 43880

BACNET RS485 COMMUNICATION

Galvanically insulated from input and auxiliary supply

Standard: RS485 – 3 wires

Transmission: serial asynchronous

Protocol: BACNET MS-TP

 Number address: 0...127

 Transmission speed: 9'600 – 19'200 – 38'400 – 76'800 bit/s

Number of bits: 8

Stop BIT: 1

Parity: none – even – odd

 Network address: 0...4000

Max. number of devices that can be network-connected: 32 (up to 255 with RS485 repeater)

Max. distance from the supervisor: 1200m

ETHERNET COMMUNICATION (NT809 - NT891)

It can be carried out with m IF2E011, IF2E111 or IF4E011 (RS485/Ethernet) interface

AUXILIARY SUPPLY

Rated value Uaux ac: 80...265Vac - 48Vac

Rated frequency fn: 50 or 400Hz (automatic selection)

Working frequency: 45...65Hz (fn 50Hz) or 360...440Hz (fn 400Hz)

Rated burden: ≤ 2,5VA (230Vac backlight 30%)

Rated value Uaux dc: 100...300Vdc

Rated burden: ≤ 2,5W (24Vdc backlight 30%)

Protected against incorrect polarity

ELETROMAGNETIC COMPATIBILITY

Emission according to EN 61326-1 class B

Immunity according to EN 61326-1

INSULATION

(EN/IEC 61010-1)

Installation category: III

Pollution degree: 2

Insulation voltage rating MFD4421SR: 300V (Phase - neutral)

Insulation voltage rating SR01D...: 1000V

PROVE TESTS

Tensione a impulso 1,2 / 0µs0,5J Voltage test 1,2 / 50µs 0,5J	Tensione alternata valore efficace 50Hz 1min Alternating voltage r.m.s value 50Hz 1min
6kV	3kV
6kV	3kV
6kV	3kV
-	4kV
-	7,4kV

ENVIRONMENTAL CONDITIONS

Reference temperature: 23°C ± 2°C

Specified operating range: -5...55°C

Limit range for storage and transport: -25...70°C

Suitable for tropical climates

Max. power dissipation¹: ≤ 5W

¹For switchboard thermal calculation

SR01D... Sensor

Reference temperature: 23°C ± 2°C

Specified operating range: -30...80°C

Limit range for storage and transport: -40...80°C

HOUSING

MFD4421SR Multifunction

Housing: 4 moduli DIN 43880

Montaggio: a incastro su profilato 35mm
Tipo profilato: a cappello TH35-15 (EN60715)
Materiale custodia: policarbonato autoestinguente
Grado di protezione (EN60529): IP54 frontale, IP20 morsetti
Peso: 250 grammi
Sensore SR01D...
Chiusura sensore: a baionetta
Conessioni: cavo con capicorda
Lunghezza cavo: 3m
Materiale custodia: poliuretano termoplastico UL94-V0
Grado di protezione (EN60529): IP67
Peso: 500 grammi (massimo)

Mounting: snap-on 35mm rail
Rail type: top hat TH35-15 (EN60715)
Housing material: self-extinguishing polycarbonate
Protection degree (EN60529): IP54 front frame, IP20 terminals
Weight: 250 grams
SR01D... Sensor
Sensor fastening: bayonet holder
Connections: cable with lag
Cable length: 3m
Housing material: UL94-V0 thermoplastic polyurethane
Protection degree (EN60529): IP67
Weight: 500 grams (max.)

PORTATA MORSETTI

INGRESSO TENSIONE
ALIMENTAZIONE AUSILIARIA
USCITE

Con capocorda: min.0,05mm² / max. 4mm²
Cavo flessibile: min.0,05mm² / max. 2,5mm²
Coppia serraggio consigliata: 0,6Nm

INGRESSO CORRENTE

Con capocorda: min.0,05mm² / max. 6mm²
Cavo flessibile: min.0,05mm² / max. 4mm²
Coppia serraggio consigliata: 1Nm

TERMINAL CAPACITY

VOLTAGE INPUT
AUX. SUPPLY
OUTPUT

With lag: min.0,05mm² / max. 4mm²
Flexible cable: min.0,05mm² / max. 2,5mm²
Tightening torque advised: 0,6Nm

CURRENT INPUT

With lag: min.0,05mm² / max. 6mm²
Flexible cable: min.0,05mm² / max. 4mm²
Tightening torque advised: 1Nm

POSIZIONE TERMINALI TERMINAL POSITION

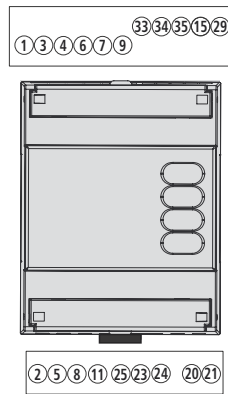

SCHEMI D'INSERZIONE WIRING DIAGRAMS

F : 0,5A gG

1n1E
Linea Monofase
Single phase network

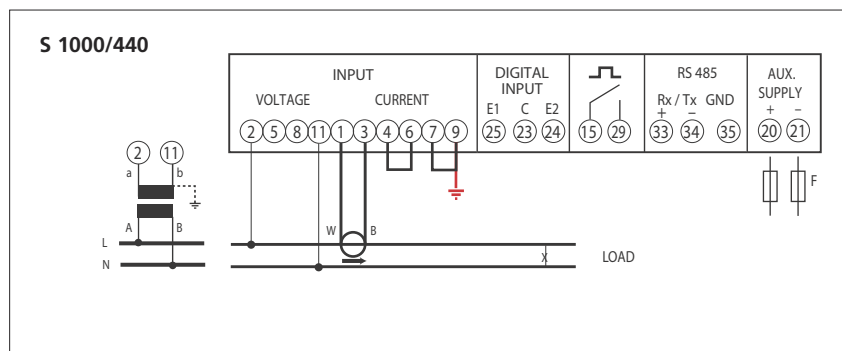

3-1E
Linea Trifase 3 Fili 1 Sistema
Three-phase 3-wires network 1 System

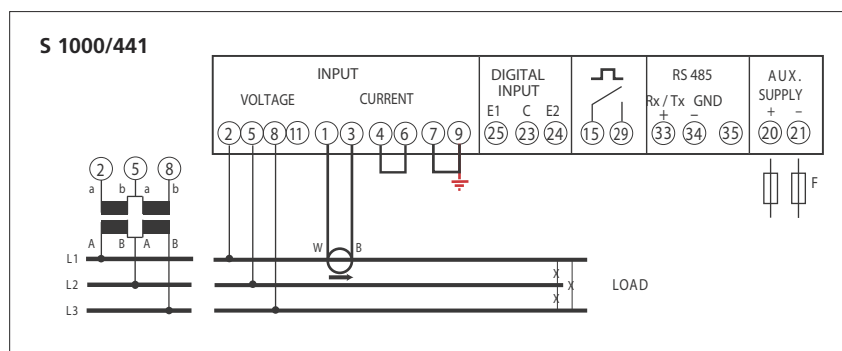

3N1E
Linea Trifase 4 Fili, 1 Sistema
Three-phase 3-wires network, 1 System

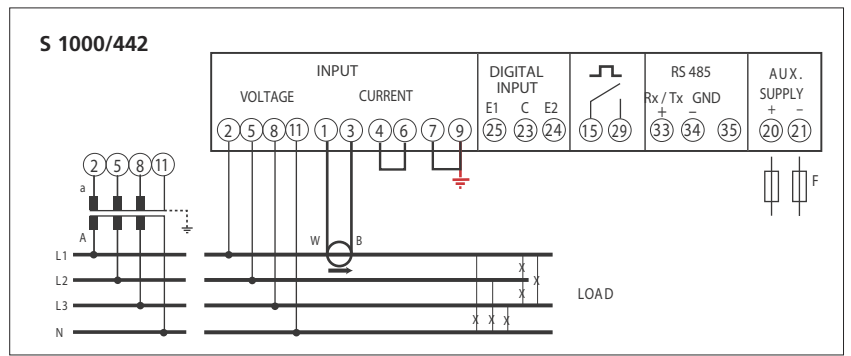

3-2E
Linea Trifase 3 fili, 2 Sistemi
Three-phase 3-wires network, 2 Systems

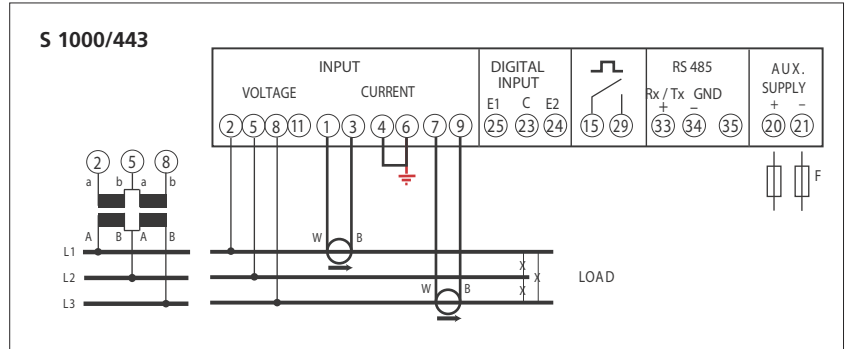

3-3E
Linea trifase 3 fili 3 Sistemi
Three-phase 3-wires network, 3 Systems

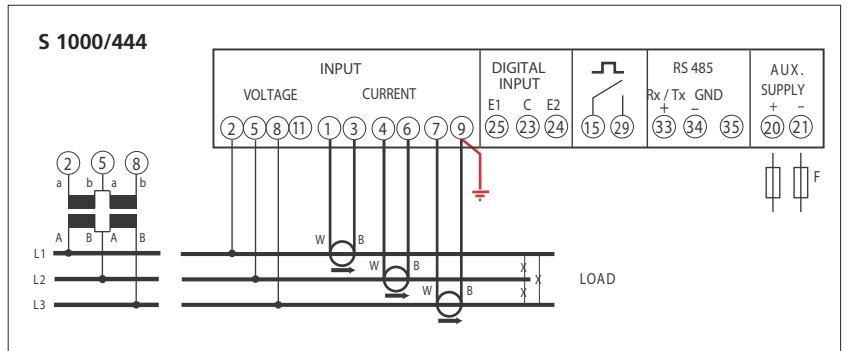

3N3E
Linea Trifase 4 fili, 3 Sistemi
Three-phase 4-wire network, 3 Systems

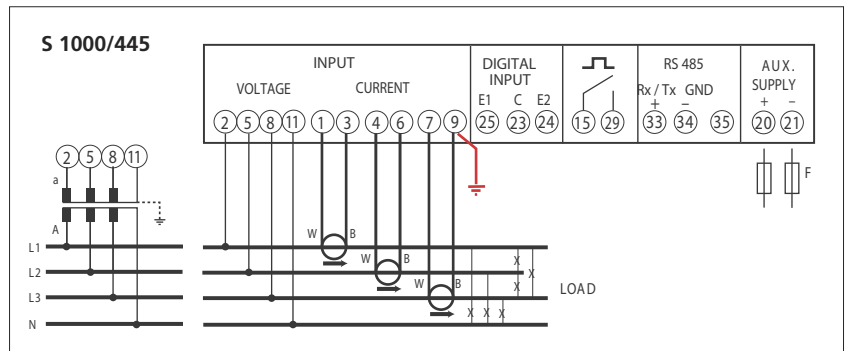

ATTENZIONE!

I collegamenti a terra riportati negli schemi di inserzione (evidenziati in rosso) sono obbligatori. Collegare alimentazione ausiliaria ai terminali 20 e 21.

ATTENTION!

The earth connections shown in the wiring diagrams (highlighted in red) are compulsory. Aux. supply must be connected to terminals 20 and 21.

DIMENSIONI DIMENSIONS

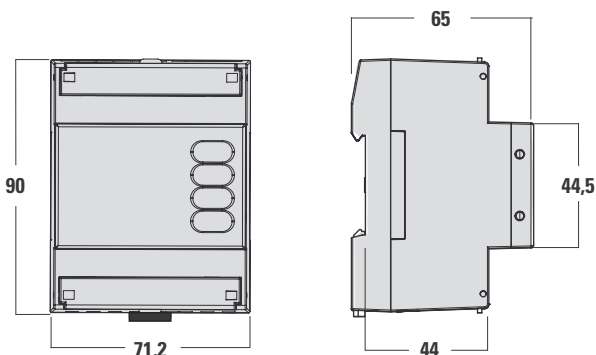

Rogowski

SR01D...

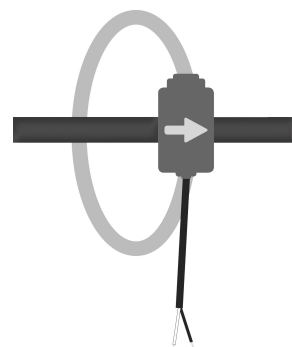

Modello Model	∅
SR01D080	80
SR01D142	142
SR01D190	190



www.imeitaly.com

La I.M.E. S.p.A. si riserva in qualsiasi momento, di modificare le caratteristiche tecniche senza darne preavviso. / I.M.E. S.p.A. reserves the right, to modify the technical characteristics without notice.